

Loft Shop flat rooflights



Designed to **maximise the amount of natural light in a building**, Loft Shop flat rooflights provide a clean, minimalistic finish both inside and out.

Key features

- Some sizes available from stock
- Immediate despatch on stocked sizes
- Competitively priced
- Secure welded glazing frame
- Range of insulated upstand curbs
- Wide range of ventilation options
- Delivery direct to contractor's yard or site
- Available with double or triple glazed
- Prefabricated unit
- Simple to install
- Flush design
- Unrivalled insulation value

Glazing

Choosing the correct glazing

Material

Glass

- ◆ Excellent insulation value
- ◆ High fire rating
- ◆ Flush design
- ◆ Flat topped unit

Double or triple-glazed

Double glazed

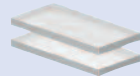

- ◆ Good insulation (1.24W/m²K)
- ◆ Recommended choice
- ◆ Good sound insulation
- ◆ Low E argon filled

Triple glazed

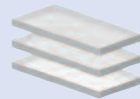

- ◆ Excellent insulation (0.87W/m²K)
- ◆ Excellent sound insulation
- ◆ Low E argon filled
- ◆ Special order

Clear or opal diffused

Clear

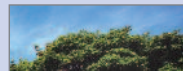

- ◆ Recommended choice
- ◆ All stocked units are in clear
- ◆ High light transmission

Opal diffused

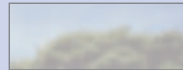

- ◆ Available to order
- ◆ Maintains high light transmission whilst evenly distributing light to area below
- ◆ Increased security due to translucent finish

Shape

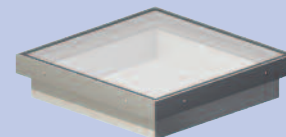

Square

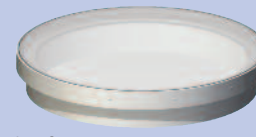

Circular (special order)

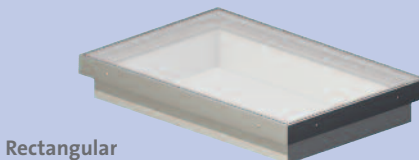

Rectangular

Upstand

Choosing the correct curb

Curb PVCu 150/s splayed

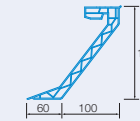

- ◆ Economical
- ◆ Insulated and thermally broken
- ◆ Can accommodate controllable trickle ventilation in side walls
- ◆ Pre-finished internally
- ◆ Suitable for most flat roof waterproofing systems

Curb PVCu 150/v vertical

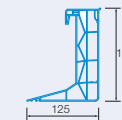

- ◆ Most popular choice
- ◆ Insulated and thermally broken
- ◆ Provides a vertical internal finish
- ◆ Can accommodate controllable trickle vents
- ◆ Pre-finished internally
- ◆ Suitable for most flat roof waterproofing systems

Curb PVCu 300 splayed

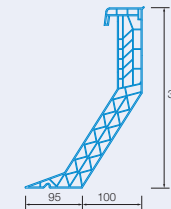

- ◆ For use on insulated roofs (up to 150mm insulation)
- ◆ Excellent insulation and thermally broken
- ◆ Can accommodate controllable trickle or rotating ventilation in side walls
- ◆ Suitable for most flat roof waterproofing system

Curb adaptors

Collar PVCu adaptor

- ◆ Thermally broken solution for replacing existing rooflights
- ◆ Accommodates non-standard existing dimensions

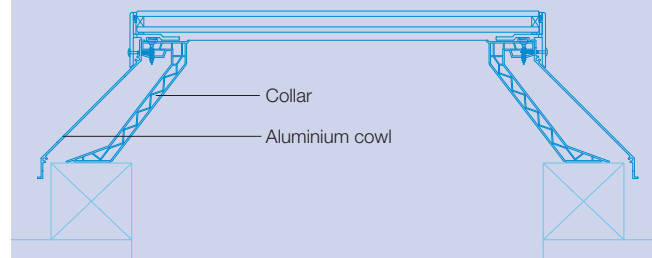

Ventilation options

Controllable trickle

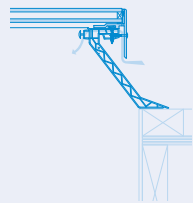

- ♦ Factory fitted
- ♦ Installed in side wall of upstand or adaptor
- ♦ Controllable trickle background ventilation
- ♦ Up to 8000mm² ventilation area per pair

Controllable rotating

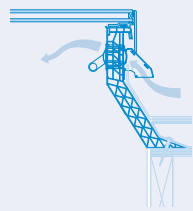

- ♦ Most effective type of fixed ventilation
- ♦ Infinitely adjustable
- ♦ Innovative insulated design
- ♦ Fitted to 2 or 4 sides of upstand or adaptors

Manual and opening ventilation

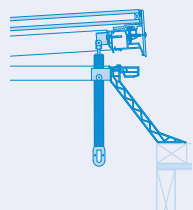

- ♦ Manual operated
- ♦ Opens up to 300mm
- ♦ Proprietary design
- ♦ Suitable for small units

Electric opening ventilation

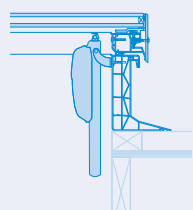

- ♦ Electrically operated
- ♦ Opens up to 180mm
- ♦ Rain sensor option
- ♦ Suitable for large and small units

Availability

Many other sizes available to special order

Dimensions explained

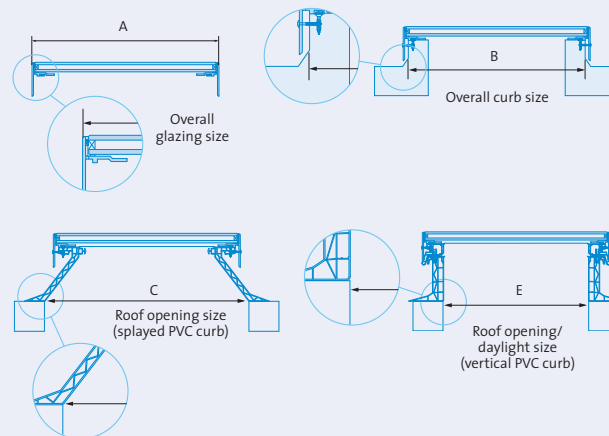

Size Ref No.	Dimension A (mm)	Dimension B (mm)	Dimension C (mm)	Dimension E (mm)
Square rooflights				
EG S2	640 x 640	600 x 600	700 x 700	500 x 500
EG S4	740 x 740	700 x 700	800 x 800	600 x 600
EG S7	940 x 940	900 x 900	1000 x 1000	800 x 800
EG S8	1040 x 1040	1000 x 1000	1100 x 1100	900 x 900
Rectangular rooflights				
EG R5	740 x 1040	700 x 1000	800 x 1100	600 x 900
EG R16	1040 x 1340	1000 x 1300	1100 x 1400	900 x 1200
EG R19	1140 x 2140	1100 x 2100	1200 x 2200	1000 x 2000

Limitation on use Loft Shop and related products as described in Loft Shop literature are designed for use in normal circumstances on flat roofs up to 15° pitch. For applications in excess of 15° or in unusual circumstances (e.g. extreme temperature or climatic conditions) please refer to Loft Shop. Please note that all information supplied is based on our best knowledge and general experience. Because of factors outside our control which can affect installation and use of products, no warranty is given or implied in respect of information provided. A policy of continuous product improvement applies and Loft Shop therefore reserves the right to alter specifications without prior notice.

Condensation Condensation occurs where warm moist air meets cold surfaces. As warm air rises, the risk of condensation forming at rooflight level is relatively greater than at lower level. The risk can be minimised by specifying double or triple skin rooflights and insulated upstands. The provision of ventilation may also assist. However, because temperature and humidity levels are clearly beyond our control, no guarantee can be given against the formation of condensation.

Technical services Full technical literature is available on request. Advice and technical assistance is always available from Loft Shop on the application and specification of Loft Shop rooflights and accessories.

Guarantee All Loft Shop rooflights, when installed on curbs or curb adaptors and in accordance with manufacturers' instructions, are guaranteed against the effects of defective design, materials or construction for a period of five years from date of supply by Loft Shop. All other products (e.g. curb adaptors, ventilation systems and other accessories) are guaranteed for 12 months from date of supply by Loft Shop.

Flat Rooflights

Brochure 2012

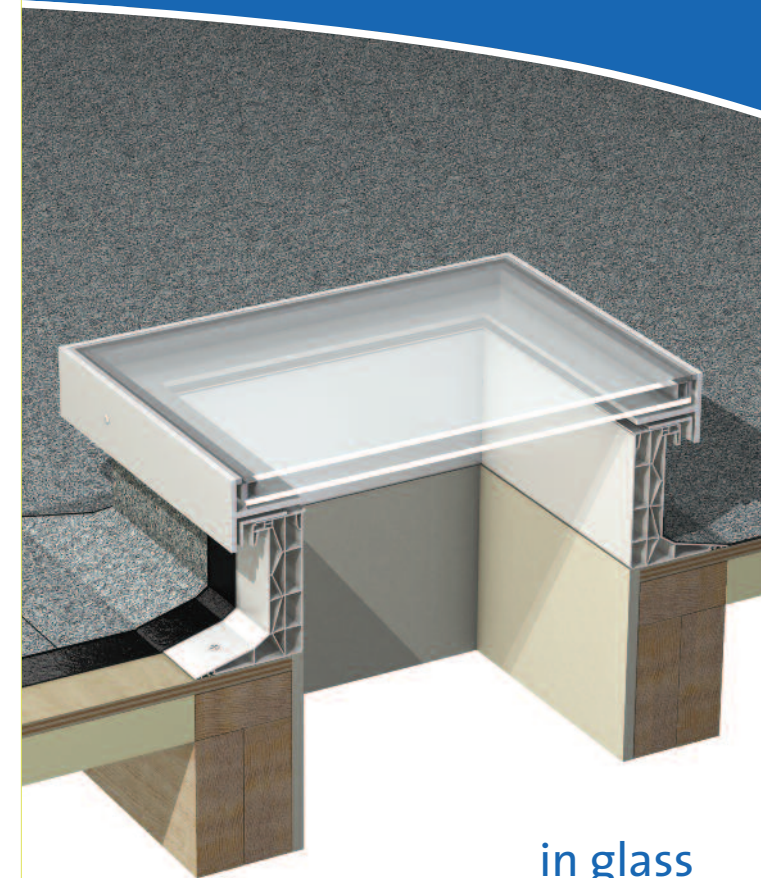

in glass



Website www.loftshop.co.uk
 Email enquiries@loftshop.co.uk
 Telephone 020 8551 5800

