



Flat Fixed Rooflight

Standard Stock Size 600mm x 900mm

Kerb/Upstand Sizes (by others)

Internal Kerb Upstand Size 600mm x 900mm

External Kerb/Upstand Size 760mm x 1060mm

Kerb/Upstand thickness 80mm (including weathering)

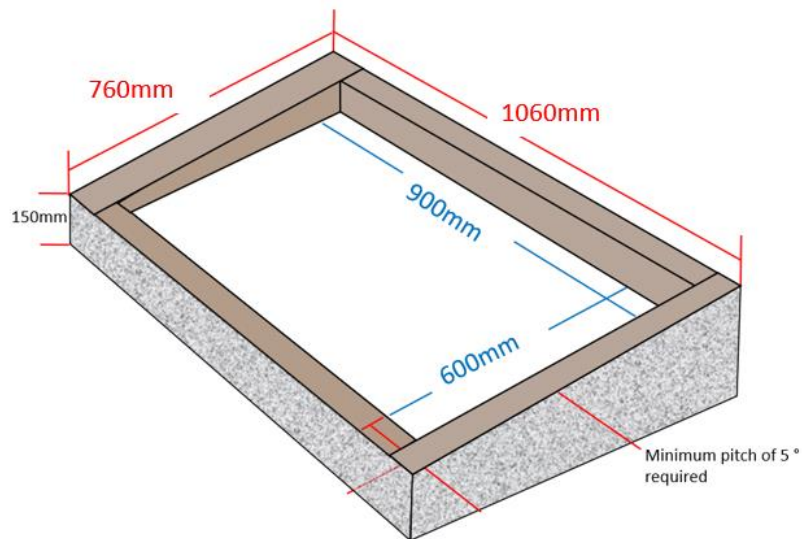

Fixed Rooflight Sizes

Internal Opening Size 600mm x 900mm

External Frame Size 781mm x 1081mm

Frame Height 119mm

